



AFM25-50

Order the UV fused silica asphere AFL25-50 as mounted lens and benefit from a perfectly aligned asphere.

Key Benefits:

- = Thread: M28 x 0.75
- = Modular design for high compatibility to common optical systems
- = Clearly labeled specifications on mount for comfortable handling
- = Available with 4 standard coatings

Technical Dimensions:

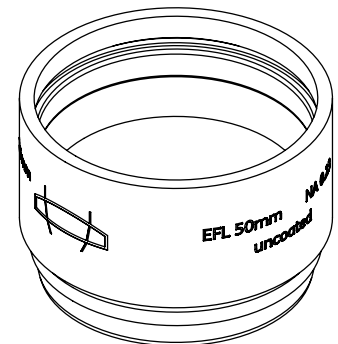
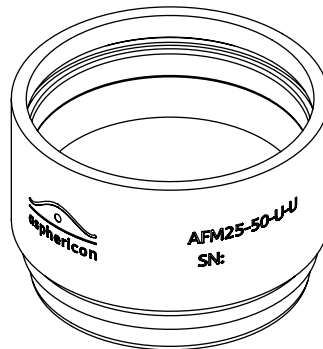
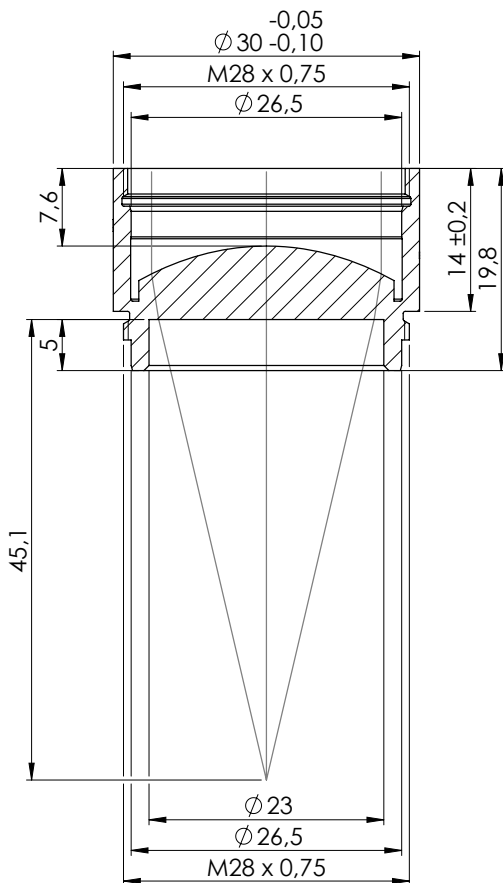

asphericon GmbH
 Stockholmer Str. 9 | 07747 Jena
 Germany

+49 (0) 3641 - 3100 560
 +49 (0) 3641 - 3100 561

asphericon, Inc.
 2601 Cattlemen Road, Suite 301
 Sarasota, FL 34232 | USA

+1 - 941 - 564 0890

asphericon s.r.o.
 Milířská 449 | Jeřmanice 463 12
 Czech Republic

+420 488 100 300

sales@asphericon.com

www.asphericon.com