

asphericon MountedOptics

AFM25-40

Order the UV fused silica asphere AFL25-40 as mounted lens and benefit from a perfectly aligned asphere.

Key Benefits:

- = Thread: M28 x 0.75
- = Modular design for high compatibility to common optical systems
- = Clearly labeled specifications on mount for comfortable handling
- = Available with 4 standard coatings

Technical Dimensions:

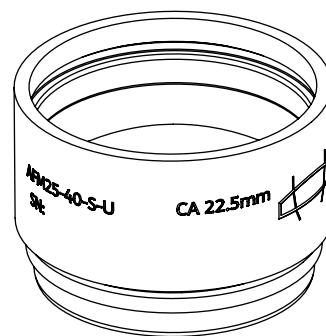
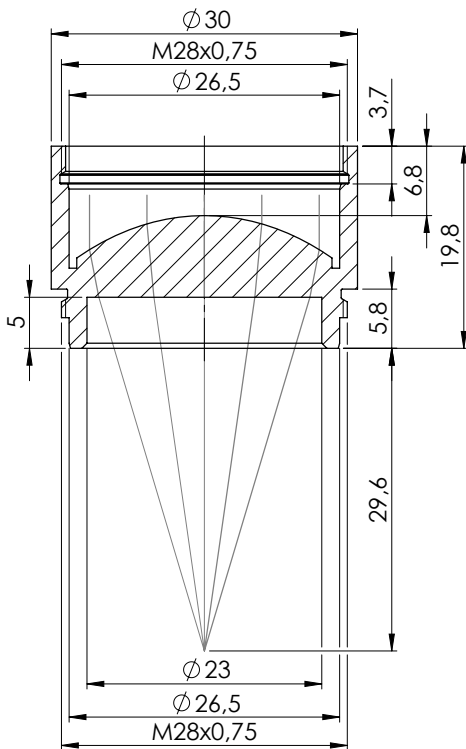

+49 (0) 3641 - 3100 560
+1 - 941 - 564 0890



+49 (0) 3641 - 3100 561
+1 - 941 - 584 4071



sales@asphericon.com



www.asphericon.com