



Gooch & Housego

• INTRODUCTION TO ACOUSTO-OPTIC MODULATORS AND DEFLECTORS:

Acousto-optic components are typically used internal or external to laser equipment for the electronic control of the intensity (modulation) and or position (deflection) of the laser beam. Interaction of acoustic waves and light occur in optical materials when the acoustic wave generates a refractive index wave, which acts as a sinusoidal grating in the optical material. An incident laser beam passing through this grating will be diffracted into several orders. With appropriate design of the modulator or deflector and proper adjustment of the incident angle between the laser light and the axis of acoustic propagation in the optical material (Bragg angle), the first order beam can be made to have the highest efficiency. The angle, (θ), the light is diffracted is defined by the equation:

$$\theta = \frac{\lambda f_a}{V_a} = 2\theta_b \quad (1)$$

Where: λ is the optical wavelength in air
 V_a is the acoustical velocity of the material
 f_a is the acoustic frequency
 θ_b is the Bragg angle

This is the angle between the incident laser beam and the diffracted laser beam, with the acoustic wave direction propagating at the base of the triangle formed by the three vectors. A diagram of the relationship between the acoustic wave and the laser beam is shown in figure 1.

The intensity of the light diffracted is proportional to the acoustic power (P_a), the figure of merit (M_2) of the optical material, electrode geometric factors (L/H) and inversely proportional to the square of the wavelength.

$$\text{Eff} = \text{Sin}^2 \left(1.57 \left(\frac{2}{\lambda^2} \left(\frac{L}{H} \right) M_2 P_a \right)^{1/2} \right) \quad (2)$$

ACOUSTO OPTIC MATERIAL SELECTION

A variety of acousto-optical materials are used for Acousto Optic Modulators depending on the laser parameters such as wavelength, polarization, and power density. Table 2 is a summary of the properties and figure of merit for most common materials used for the NEOS Technologies acousto optical modulators. For the visible region and near infrared region, the most common modulators are made from dense flint glass, fused Silica, crystal Quartz, Tellurium Dioxide, or chalcogenide glass. At the infrared region, Germanium is the most common material with a relative high figure of merit. Lithium Niobate and Gallium Phosphide are used for high frequency signal processing devices.



FIGURE 1

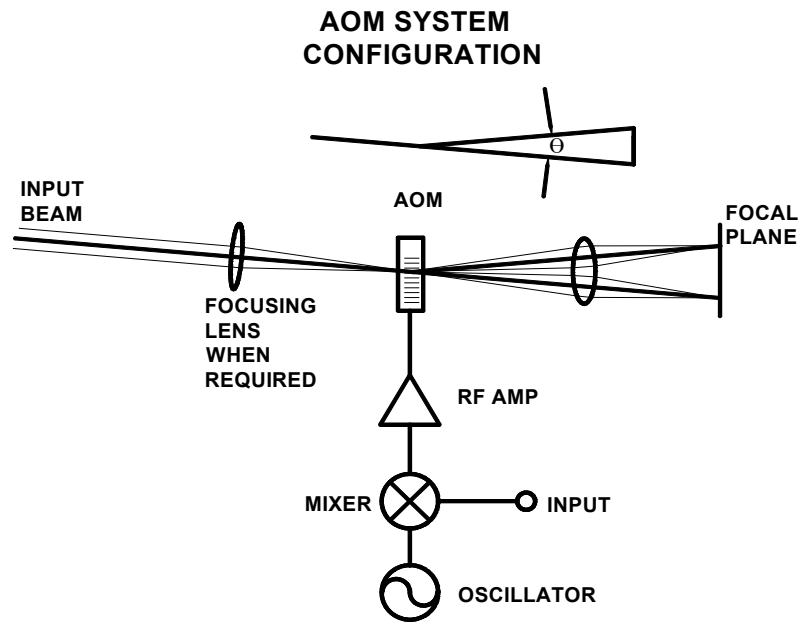

ACOUSTO-OPTIC MODULATOR CONSTRUCTION

Once the acousto-optic material is selected, it is optically polished. The surfaces of the material that are to be the optical windows are optically AR coated to reduce optical reflections. NEOS uses multi-layer dielectric broadband or “V” AR coatings on the AO modulator optical windows. Typical losses are from a few percent for external cavity devices to 0.2 percent for intra-cavity devices. The side of the material that the acoustic energy is to originate from has a Lithium Niobate transducer metal vacuum bonded to the modulator medium. The transducer converts RF energy applied to it into acoustic energy. Metal bonding provides very good acoustic coupling and NEOS uses only high quality metal bonds. Then the transducer is lapped to the fundamental resonant frequency such as 80 MHz. The top surface of the transducer is then metalized with the transducer shape and size defined in this process. The modulator is then tuned to match the electrical impedance of the RF driver, which will supply the RF energy at the frequency of the transducer’s resonant frequency.

RF DRIVER CONSTRUCTION

The RF driver is typically a fixed frequency oscillator and usually consists of a crystal oscillator, an amplitude modulator with an interface, which accepts input modulation, digital and / or analog, and a RF amplifier, which supplies the AO modulator with the level of RF power needed to achieve the highest diffraction efficiency. The specifications brochures on our web site describe the performance of the modulator and driver systems in detail.

DIGITAL MODULATION AND LASER BEAM SHUTTERING

An acousto-optic modulator can be used to shutter a laser beam on and off. By applying a digital TTL signal to the modulator's driver digital modulation input, the RF energy applied to the modulator is modulated on and off. To support the on-off signal, the rise time of the modulator system has to follow the digital waveform transition. The limit of the acousto-optic modulator rise and fall time is the transit time of the acoustic wave propagation across the optical beam. The rise time is given by:

$$t_r = \frac{DIA}{1.5 V_a} \quad (3)$$

A typical rise time for a 1 mm diameter laser beam is around 150 nanoseconds. To achieve faster rise times, it is necessary to focus the laser beam through the modulator and decrease the acoustic transit time. A schematic of the focused modulator setup is shown in Figure 1. Since the incident beam is a convergent instead of a collimated beam, the diffraction efficiency decreases as the ratio of the optical beam convergence and the acoustic beam convergence angle increases. For those interested in the design procedure for a wide bandwidth acousto-optic modulator, refer to reference 1. A plot of rise time vs. spot size for three, common AO modulator materials are given in Figure 2.

Figure 2

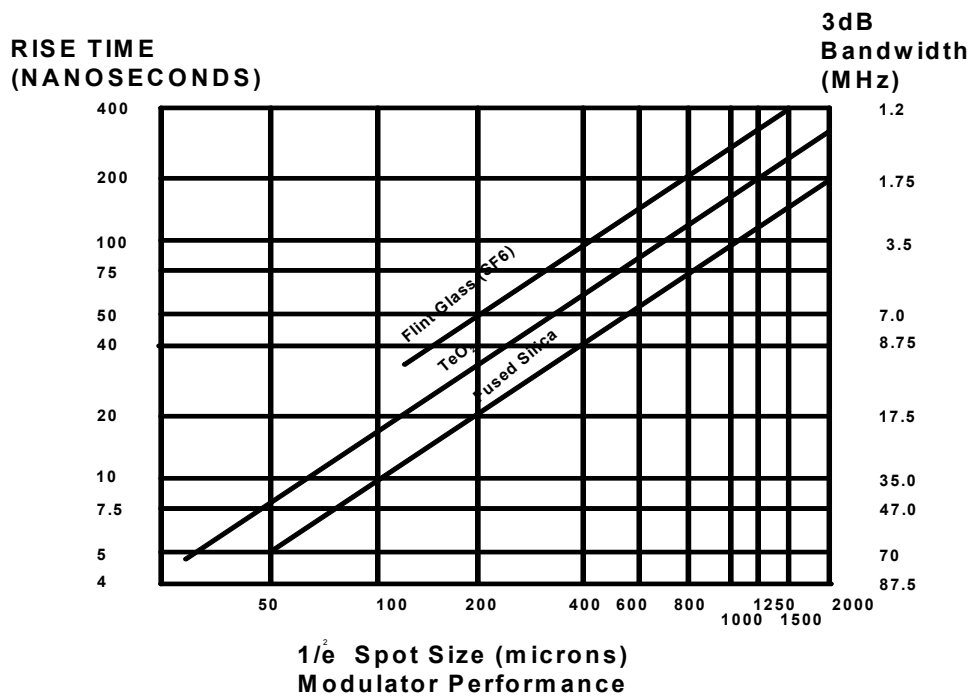

ANALOG MODULATION

A acousto-optic modulator has a nonlinear transfer function, and as a result, care must be exercised when applying an analog modulation signal to a acousto-optic modulator. For simple gray level control, the best approach is to characterize the transfer function and apply the appropriate voltage levels into the driver's analog modulation input port. For sinusoidal modulation, a bias is required to move the operating point to the linear region of the transfer function and focussing may be necessary to ensure that the rise time is adequate. The modulation transfer function model is given by Figure 3.

$$\text{MTF} = \exp\left(-\left(\frac{f_m}{1.2 f_o}\right)^2\right) : f_o = \frac{.35}{\text{tr}} \quad (4)$$

where f_m is the modulating frequency

The modulation contrast ratio can also be obtained from experimental measurements:

$$\text{MT} = \frac{(I_{\text{max}} - I_{\text{min}})}{(I_{\text{max}} + I_{\text{min}})} \quad (5)$$

Where I_{max} = max laser intensity measured.

I_{min} = min laser intensity measured.

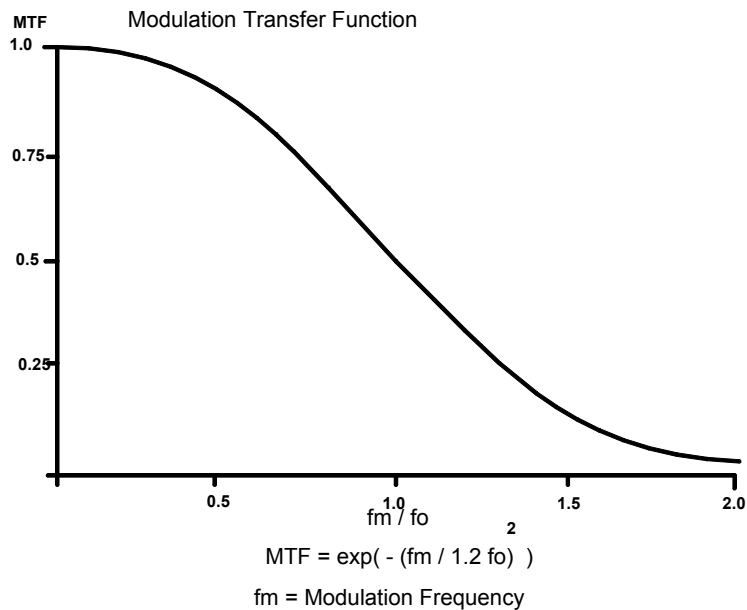

Figure 3

CONTRAST RATIO

The contrast ratio is defined as:

$$CR = \frac{I_{\max}}{I_{\min}}, \text{ for the first order diffracted beam} \quad (6)$$

In the DC case, I_{\min} consists of contributions of the scattered light and of light leakage due to the extinct RF power driving the modulator. For maximum contrast ratio, I_{\max} must be optimized. This is done by maximizing the diffraction efficiency of the acousto-optic modulator through careful adjustment of the Bragg angle and optimizing the RF drive power. Application of too much RF drive power causes the diffraction efficiency to be reduced. Light leakage (I_{\min}) due to the extinct RF power driving the modulator can be reduced by changing the driver's operating frequency to an idle frequency when the light is desired to be off, there by, the residual light can directed away from the optical path. The DC scattered light can be reduced by use of a beam block. An optimized DC contrast ratio is between 500:1 and 1000:1.

For higher modulation rates, the contrast ratio is reduced due to the loss in diffraction efficiency from the application of the required lens to focus laser light to the needed smaller spot size to achieve the needed rise and fall time in the acousto-optic modulator. Also, I_{\min} increases and I_{\max} decreases as the modulation frequency increases as both the modulator's frequency response and the RF driver's frequency response degrades in performance due to rise and fall time. (eq. 4)

APPLICATIONS OF ACOUSTO-OPTIC MODULATORS:

Acousto-optic modulators can perform other tasks in modulating the laser beam in addition to digital and analog modulation. By careful design, a special class of Acousto optic modulators can be made that modulate more than one wavelength at a time. This will be discussed in the following section on AOTFs and PCAOMs.

By coupling the laser light into and out of the modulators with a fiber optical cable, the modulators can be used as a switch in the communications industry. This will be discussed in the section on fiber optical interface to acousto-optic modulators

By careful broadband design of the transducer and by varying the frequency of the drive signal, the angle that the laser beam is deflected will change. Deflection of the laser beam will be discussed in the section on Acousto-Optic Beam Deflectors (AOBD).

When the laser beam passes through the Acoustic wave in the acousto optic material, the interaction causes the frequency of the light (Wavelength λ) to be shifted by an amount equal to the acoustic frequency. This frequency shift can be used for heterodyne detection applications, where precise phase information is measured and can be used to measure distance and velocity accurately.

An AO modulator, called a Q-Switch, typically operating internal to the cavity of a CW pumped Nd:YAG lasers produce greater than 10 kW power pulses with pulse widths of 40-200 nanoseconds wide and repetition rates of up to 100 KHz.

An AO modulator, called a Cavity dumper, typically operating internal to a Ar⁺ laser cavity produces peak power around 100 Watts and a pulse width of 15 nanoseconds and has a repetition rate of up to 1 MHz.

An AO modulator, called a Mode locker, typically operating internal to a Titanium Sapphire laser cavity modulates the laser at the resonance frequency of the laser cavity, causes the longitudinal modes of the laser to be in phase. This produces very narrow laser pulses having less than 100 femtoseconds pulse width and typically with peak power of around 150 kW.

For more information on the analysis and design of acousto-optics, refer to references 1, 2, and 3. NEOS Technologies can assist you in answering technical questions in regard to acousto-optics.

ACOUSTO-OPTIC TUNABLE FILTERS (AOTF) AND POLYCHROMATIC ACOUSTO-OPTIC MODULATOR SYSTEMS (PCAOM):

A normal AO modulator is designed to modulate only one wavelength of laser light as the Bragg angle must be changed for any other wavelength of light. A special class of modulators has been developed to modulate multi-wavelength or white light lasers. These modulators are known generally as **Acousto-Optic Tunable Filters** or by the light show industry, as **Poly-Chromatic Acousto-Optic Modulators**, and is based on the work of I. C. Chang [8] using Tellurium Dioxide (TeO_2) crystals in the slow shear mode. The wavelength tuning curve for these modulators are shown in figure 4.

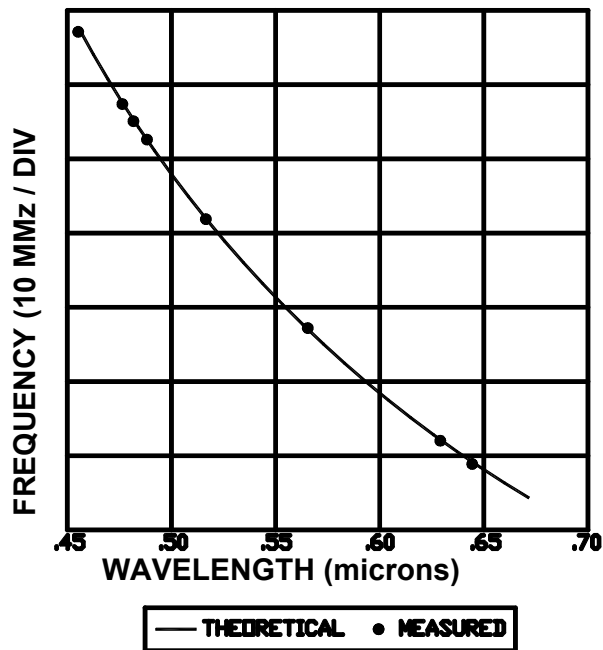

45A8309

PCAOM WAVELENGTH TUNING CURVE

Figure 4

The angle between the diffracted beams for the different wavelengths is 2.5 degrees for a normal TeO_2 device. By designing a small prism to compensate for the angular variation, and by taking advantage of the dispersion property, the net angular deviation of the different wavelengths diffracted is reduced to .002 degrees. Since this is within the normal beam divergence of the laser beam, the output can be considered to be co-linear. This allows one PCAOM modulator to be used in the light show industry to modulate the multi-wavelength lasers instead of using several different modulators, one for each wavelength. NEOS produces several models of the PCAOM modulator for use in the visual spectrum.

THE IDEAL PCAOM SHOULD HAVE THE FOLLOWING CHARACTERISTICS:

- 1) Large acceptance angle. This allows for alignment insensitivity to movement and allows for good performance with diverging beams.
- 2) Narrow optical bandwidth. This allows for rejection of neighboring wavelengths that will prevent chromatic cross-talk.
- 3) High throughput efficiency. This prevents one from having to generate excessive RF power in order to achieve acceptable levels of throughput.
- 4) Low RF drive frequency. This prevents acoustic losses that are more prevalent at the higher RF frequencies.
- 5) Light polarization. Ideally this should be vertical to the mounting surface since most lasers have their light output oriented in this direction.
- 6) Small optical cell size. TeO₂ is an expensive optical material so using less will result in a lower cost PCAOM.

The following discussion considers the different tradeoffs in the design of two NEOS PCAOMs. The NEOS on-axis acoustic wave PCAOM 48062-2.5-.55 is compared to an off-axis acoustic wave 48058-2.5-.55 PCAOM design. Issues to be reviewed in the in the chart below include filtering bandwidth, throughput efficiency, RF drive frequency, optic cell size, light polarization, and acceptance angle.

Advantages for each are shown in bold

<u>Parameter</u>	<u>48062-2.5-.55</u>	<u>48058-2.5-.55</u>
<u>Acceptance angle</u>	< 1 mrad	< 30 mrad
<u>Optical bandwidth</u>	4.0 nm	7.5 nm
<u>Throughput efficiency</u>	92% w/ 120 mW	93% w/ 130 mW
<u>RF drive frequency</u>	40 to 75 MHz	48 to 80 MHz
<u>Light polarization direction</u>	Horizontal	Vertical
<u>Optical cell size</u>	1.08 cc	0.816 cc

The advantage for the light show industry lies with the NEOS 48058-2.5-.55 PCAOM, as one of the most important operating parameters is acceptance angle. Having a narrow acceptance angle causes problems with optical alignment in the field. Each time a system incorporating the PCAOM is shipped or moved, slight movements of the PCAOM can occur. This can result in a degradation of the throughput efficiency and thus require realignment and adjustment for Bragg angle. The design for the 48058-2.5-.55 PCAOM is more tolerant to misalignment caused by movement during setup in the

field. Also, the narrow acceptance angle of the 48062-2.5-.55 would require a more collimated laser beam to prevent additional throughput losses experienced when using the more divergent, higher power laser used for light shows.

The apparent disadvantage for the 48058-2.5-.55 PCAOM however, is with the optical bandwidth. This leads to chromatic cross talk between neighboring wavelengths. Test data was plotted showing the level of cross talk for each operating wavelength typically available out of an Ar⁺/Kr laser. Even though the 48062-2.5-.55 has a worse case cross talk of 10%, it is in the red wavelengths that are less eye sensitive, while the 48058-2.5-.55 has a worse case cross-talk of 25% and 11% in the more eye sensitive green. Of course the cross talk was measured with the light level being referenced against the selected wavelength. Operating at 520 nm out of a typical Ar/Kr laser one observes a worse case condition of having the 520 nm line being 20% of the 514 nm line's intensity. Then the resulting cross talk becomes 20% of the 25% 514nm cross talk indicated above or 5%, which is reasonably dim. However, the 514 nm line out of a typical Ar/Kr laser is one of the strongest in intensity so the 11% 520 nm cross talk is referenced against a bright line and therefore will show significant visibility.

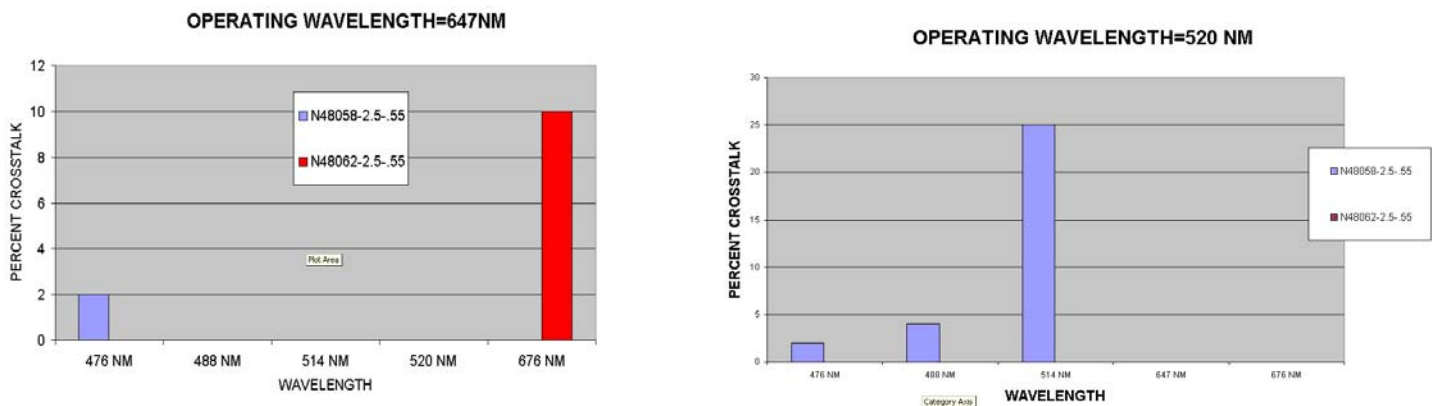

The whole cross talk issue above is academic if one realizes that many light display systems use a three-color RGB configuration. In this situation, any amount of cross talk between 514 and 520 will be negated since both of these green lines will be turned on simultaneously during light shows.

A description of the design and performance of a NEOS 48062-2.5-.55 PCAOM and a 48058-2.5-.55 are given below:

RF DRIVE POWER

Due to the high figure of merit for TeO₂, the drive power required to achieve up to a 85% efficiency per wavelength is low. Table1 below list the drive power for several wavelengths for both the 48062 and the 48058 PCAOMs.

Table 1

MODEL	48058-2.5-.55	48062-2.5-.55
WAVELENGTH	DRIVE POWER	DRIVE POWER
(nm)	(+/- 25 mW)	(+/- 25 mW)
647	130	120
568	120	50
514	104	60
488	88	60
476	90	70
457	90	70

OUTPUT ANGLE AND VARIATION AS A FUNCTION OF WAVELENGTH

The deflection angle between the wavelengths is 2.5 degrees for a standard TeO2 Modulator. By properly designing a small prism to compensate for the angular variation, the net angular deviation of the diffracted beams is reduced to 0.002 degrees. This is a very small angle and, therefore, the output is collinear. The addition of this prism results in the output beam being displaced by 4.5 degrees from the input beam for the 48062-2.5-.55. For the 48058-2.5-.55 the output beam is displaced by 1.4 degrees.

SPECTRAL RESOLUTION

The closest laser lines in an Ar⁺ laser is 6 nm apart. Figure 5 shows the measured response for the 48062 PCAOM. Figure 6 shows the measured response for the 48058.

Figure 5

48062 Frequency Response

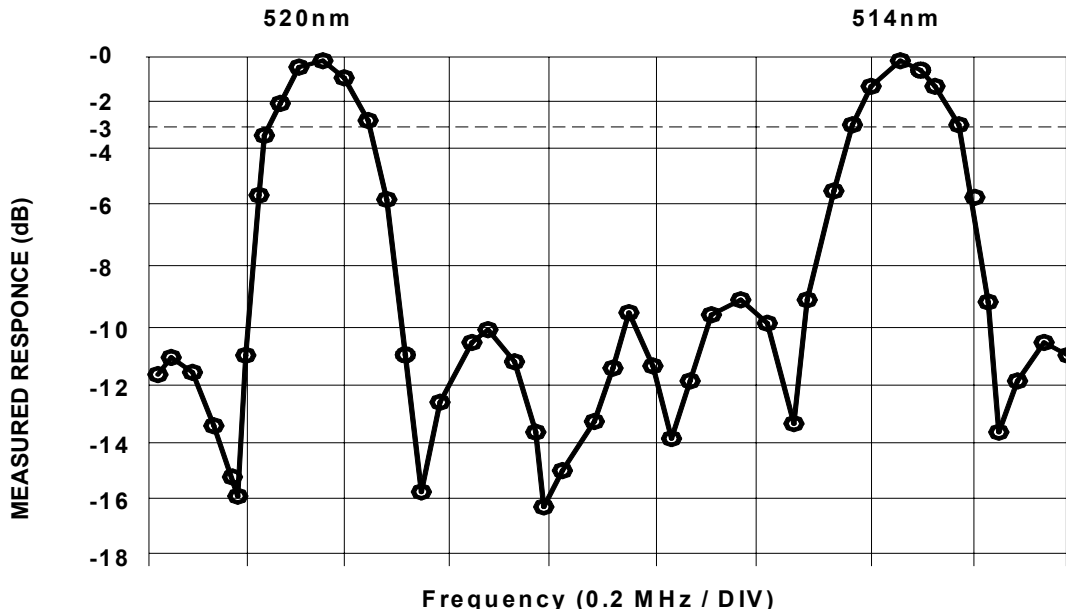
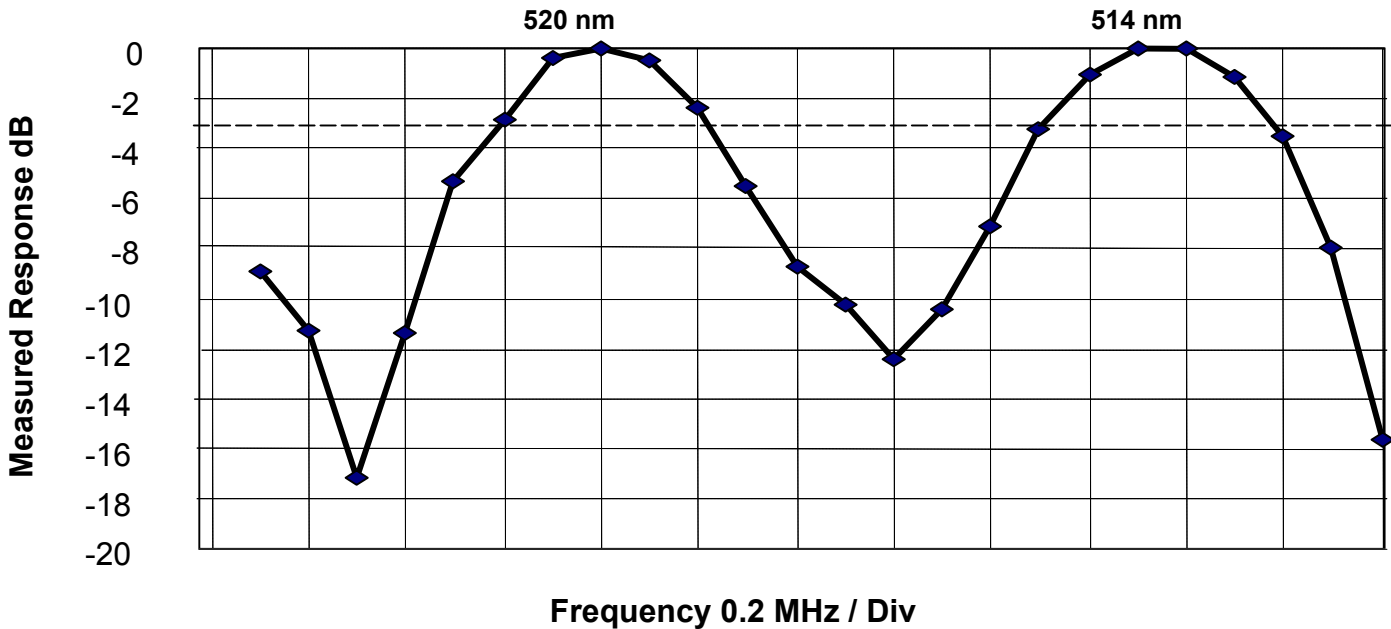

Figure 6
48058 Frequency Response



The 48062 PCAOM shows a spectral line width of about 1.7 nm at 514 nm and for the worse case (longest wavelength) is 4.0 nm. The 48058 PCAOM shows a spectral line width of about 2.3 nm at 514 nm and for the worse case (longest wavelength) is 7.5 nm.

INPUT ACCEPTANCE ANGLE

The input acceptance angle for the 48062-2.5-.55 PCAOM is <math><1</math> mrad (solid angle). Although this angle is fairly tight, alignment is similar to standard AOMs. For the 48058-2.5-.55 PCAOM the acceptance angle is ≤ 30 mrad (solid angle) allowing easy alignment of the device in the optical system.

TEMPERATURE VARIATION

The PCAOM is sensitive to temperature. The measurements show a sensitivity of 10 to 16 KHz per $^{\circ}\text{C}$. Since a 3 dB bandwidth of the PCAOM is about 200 KHz, a ± 5 $^{\circ}\text{C}$ variation can be tolerated.

POWER HANDLING CAPABILITY

The typical laser used in the light show industry produces 20 Watts optical power. When the crystals have impurities, the effects are seen as blooming (thermal lensing) in the output beam. All of materials selected for making the NEOS PCAOMs are for high power operation.

OPTICAL EXTINCTION RATIO

The extinction ratio is very important. Careful design of the RF driver provides a good extinction ratio of typically more than 40 dB in the image plane modulated and with blanking, the extinction ratio is greater than 60 dB.

PCAOM MODULATOR DRIVERS

The PCAOM driver is designed to generate the needed RF frequencies to select the desired output wavelengths with a 0 to 5 Volt AM input and TTL blanking signal and can be driven directly from a computer. Crosstalk is at least 20 dB down optically between wavelengths. Frequency stability is .01%, 0 to 60⁰ C for our frequency synthesized 8 channel (8 selectable optical frequencies) drivers and the frequency can be tuned in 8 KHz steps to accommodate for any temperature changes in the PCAOM. The NEOS PCAOM drivers are made in 4 and 8 channel systems (rack mountable box) and OEM modules.

APPLICATIONS OF THE PCAOM AND AOTF

The PCAOM is a perfect Modulator for the multi-wavelength Argon ion laser or the Krypton-Argon laser used in the laser light show applications. The NEOS PCAOM devices come in standard and weather-proof cases.

Applications for the AOTF modulators include fluorescence spectroscopy and medical applications and can be made for wavelengths from 0.4 μm to 5 μm . Large aperture AOTFs are available up to 25 mm.

FIBER OPTICAL INTERFACE TO ACOUSTO-OPTIC MODULATORS:

Many of the key characteristics of acousto-optic modulators make them ideal for use in fiber optical applications. NEOS has developed a family of modulators, which are fiber coupled. 2, 3 and 4 port modulators allow for digital switching of optical path, analog modulation (Attenuation), and frequency shifting applications. NEOS' fiber coupled modulators are available as OEM modulators with drivers and systems (AO modulators and drivers integrated in one package).

FIBER OPTICAL APPLICATIONS

Applications of fiber coupled acousto-optic modulators include: Characterization of gain performance of optical amplifiers and long distance optical fiber communications, laser linewidth measurement, low noise signal transmission, and tunable filters for WDM applications. See the references listed for details. [9 - 20]

ACOUSTO OPTIC BEAM DEFLECTORS:

Acousto-Optic Beam Deflectors (AOBD) are used to control the position of a laser beam as well as modulation. By careful broadband design of the transducer and by varying the frequency of the drive signal, the angle that the laser beam is deflected will change. The AOBD typically deflects the laser beam over a fraction of a degree to a couple of degrees with a resolution of a few hundred spots to an upper limit of about two thousand spots. Typical diffraction efficiencies are 40-70 percent.

AOBD OPTICAL AND ELECTRICAL SYSTEM SETUP

A schematic setup of the AOBD and drive electronics is shown in Fig. 7.

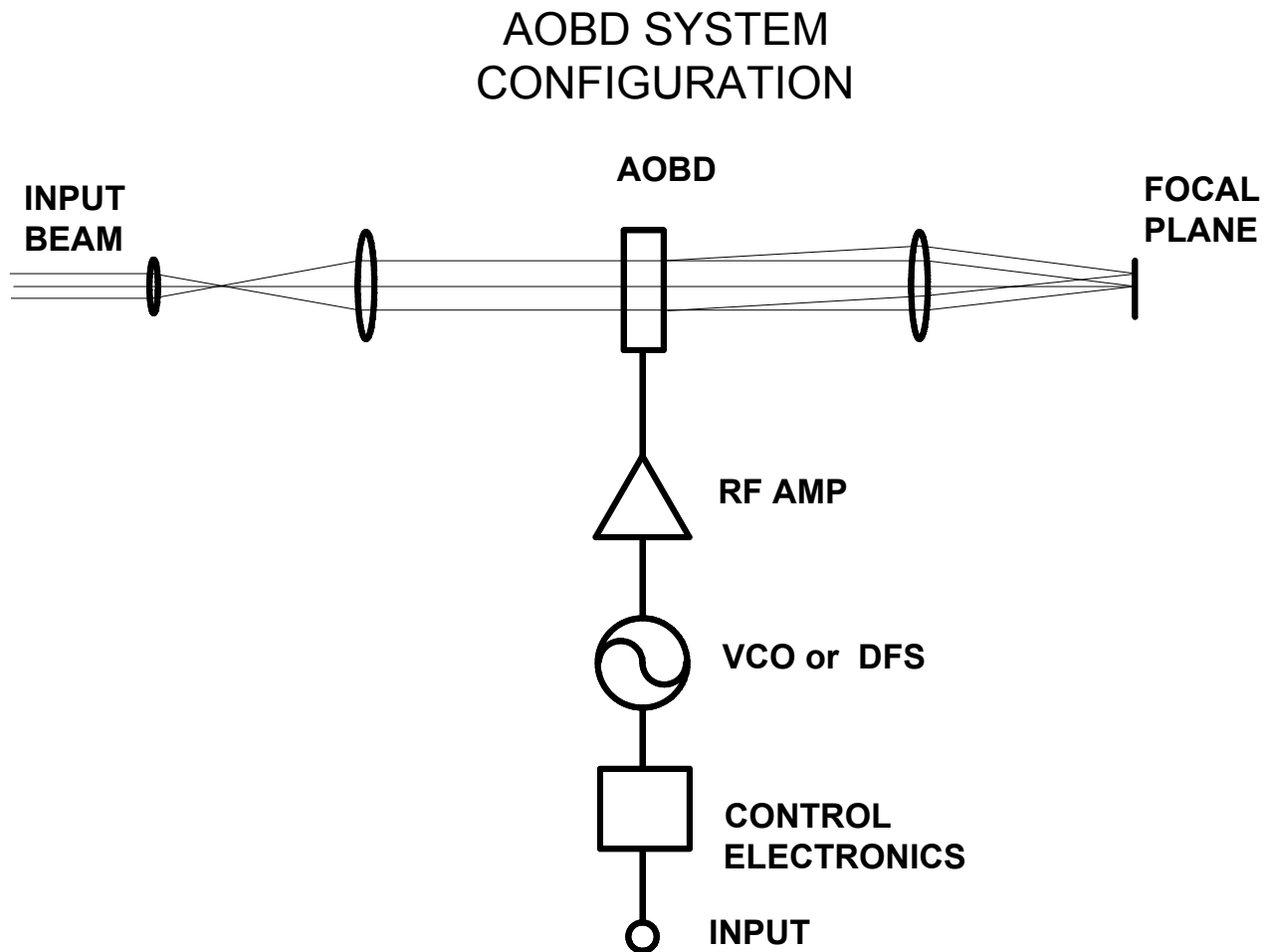

FIGURE 7

One of the AOBD's physical characteristics of concern in an optical system design is its optical aperture dimensions optical height (H), and the width (D). Usually, the optical width is much larger than the height because of performance and design constraints. As a result, the input and output optical laser beam will require cylindrical optics to transform the incident laser beam from a circular beam to a truncated profile rectangular beam, and then back to a circular beam after the deflector. The output optics usually focuses the deflected circular beam to a line of focused spots in the output plane. NEOS has developed a special group of slow shear wave Tellurium Dioxide (TeO₂) crystals deflectors that accepts a circular laser beam and does not need cylindrical lens transformation. This can simplify many applications.

AOBD DESIGN EQUATIONS

In the section on acousto-optic modulators, there is a presentation on acousto-optic material selection, angular deflection vs. input RF frequency, and diffraction efficiency. These calculations are also valid for the AOBD.

GENERAL DEFINITION ON OPTICAL DEFLECTOR RESOLUTION

Optical deflectors, whether they are mechanical or solid state in nature, obey the same fundamental equations for resolution. Assume the deflector aperture is D. The natural divergence of a collimated laser beam of width D is equal to:

$$\Delta\Theta = \frac{\lambda}{D} \quad (7)$$

If the total scan angle of the deflector is defined as $\Delta\theta$, then the total number of resolvable spots is:

$$\begin{aligned} N &= \frac{\Delta\theta}{\Delta\Theta} \\ &= \frac{\Delta\theta D}{\lambda} \end{aligned} \quad (8)$$

The above equation holds for all deflectors. Now, this equation is applied to the AOBD.

The total angular sweep of the AOBD is:

$$\Delta\theta = \frac{\lambda \Delta Fa}{V_a} \quad (9)$$

λ is the optical wavelength

ΔFa is the acousto-optic bandwidth

V_a is the acoustic velocity

Examples of typical AOBD scan characteristics are shown in figure 10 at the end of this document.

Now substitute θ into the resolution equation. Then,

$$N = \frac{\Delta F a D}{V a} \quad (10)$$

$$= \Delta F a \times \Delta T$$

Or in other words, the number of resolution elements N , is equal to the aperture time ΔT of the AOBD multiplied by the acousto-optic bandwidth $\Delta F a$, (**commonly known as Time Bandwidth product**). The value N is obtained with uniform illumination of the aperture D . When the output of the deflector is focused to a spot, the neighboring spots are such that the peak of one intensity spot is on the first zero intensity of the neighbor. The two spots cross over at the 40% intensity points, and the spot profiles are shown in Fig. 8. There are several factors that will degrade the total number of resolution elements, and these will be discussed below.

FIGURE 8

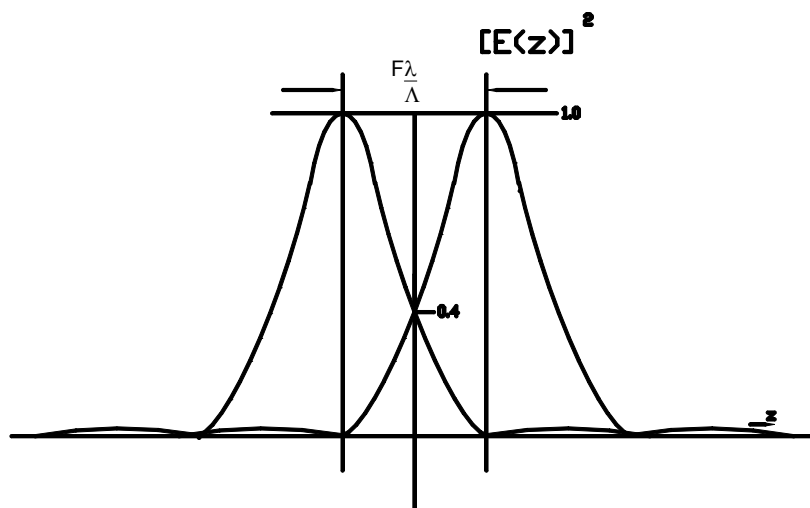

MODULATION TRANSFER FUNCTION

When dealing with laser deflection or scanning of an entire line or frame, it is necessary to consider the modulation transfer function or the contrast ratio. A parameter p , the truncation ratio of the laser beam illuminating the AOBD, is defined as:

$$p = D/W \quad (11)$$

where W is the diameter of the laser beam at the $1/e^2$ intensity points

A plot of the modulation transfer function is shown in Figure 9. For example, with $p = 0$, (uniform illumination) and an MTF of 0.5, the maximum number cycles per line is equal to $\Delta Fa \times \Delta T/2$. With $p = 1$, the intensity drops to $1/e^2$ at the ends of the aperture. The resolution in cycles per line is about $\Delta Fa \times \Delta T/2.1$

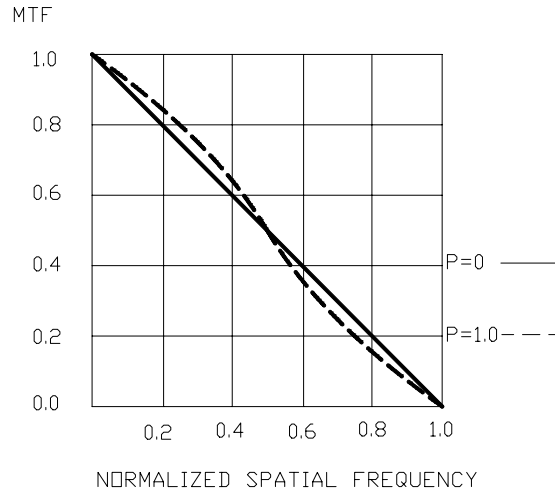

FIGURE 9

SCAN FLY BACK TIME

Since it takes a finite time for the acoustic energy to fill the AOBD, the total number of resolvable spots is reduced to:

$$N = \left(1 - \frac{\Delta T}{T - \Delta T}\right) \left(\frac{\Delta T \Delta Fa}{a}\right) \quad (12)$$

Where: T is the total linear FM scan time
 "a" is parameter for uniformity of illumination
 a = 1 for uniform beam illumination
 a = 1.34 for gaussian beam illumination

CYLINDER LENSING EFFECT

The linear FM modulation in the AOBD produces a lensing effect in addition to deflection. The focal length (FL) of the acoustic lens is given by:

$$FL_a = \frac{Va^2}{\left(\lambda \cdot \frac{dFa}{dt}\right)} \quad (13)$$

Where $\frac{dFa}{dt}$ is the FM slope.

This lensing effect must be taken into the design of any optical system using an AOBD. This lensing effect can also be useful in some applications.

AOBD APPLICATIONS:

A variety of operations can be performed with these devices: They include single axis (1 D) and two axis (2 D) laser beam deflection and optical signal processing. The electronics for the deflector are arranged in one of three ways depending on the application. First, for **continuous laser beam deflection**, the deflection angle is directly proportional to the RF frequency. Therefore, a linear voltage controlled oscillator (VCO) or a digitally frequency synthesizer (DFS) is used to drive the RF amplifier for the AOBD. For a continuous line scan, a linear sawtooth waveform drives the VCO, outputting a linear FM signal. Since the frequency linearity is extremely important, it is necessary to have additional digital electronics to correct for small non-linearity of the VCO. This signal will drive the AOBD to output a line scan. The scan rate is limited by the scan fly back time (eq. 12) and the lensing effect (eq. 13).

In the second application where **vector (random) scanning** is needed, then the electronic input is usually a digital word, which causes a different frequency to be output for each word. The location of the AOBD output beam is represented by the digital word. A D/A circuit converts the digital signal to an analog signal, and the analog signal in turn drives the linear VCO. With this electrical input, the AOBD deflects the laser beam to a specific point in the output plane. To address the next location, consideration must be given to the minimum access time which is equal to the sum of the AOBD aperture time (D / Va) plus the electronics retrace time.

In the third application, for **signal processing**, the AOBD or Bragg cell is driven by an input RF signal from an amplifier which brings the signal of interest to the appropriate RF power level for the best performance of the AOBD. Typical signal processing involves spectral analysis of the input signal for frequency information or presence or detection of a specific signal; correlation to the presence of specific signal; template testing, where the original signal can not be present in the encoded signal, and radar signal analysis for ambiguity.

NEOS AOBDs are typically made of TeO_2 which are ideal for 1D or 2D scanning and signal processing. For more detailed analysis of the AOBD, refer to the references. NEOS Technologies can assist you in answering technical questions in regard to acousto optics.

MODULATOR AND AOB REFERENCE:

1. E.H. Young & S. K. Yao "Design Considerations for Acousto Optic Devices" IEEE Proceedings, Pp 54-64, Jan 1981.
2. I. C. Chang " Acousto Optic Devices and Applications", IEEE Proceedings, Sonics and Ultrasonics, pp 1-22, Jan 1976.
3. N. Uchida and N. Niizeki, "Acousto OPTIC Deflection Materials and Techniques, IEEE Proceedings, pp 1073-1092, Aug. 1973.
4. L. Dickson "Optical Considerations for an Acousto Optical Deflector", Applied Optics, pp 2196-2202, Oct. 1972.
5. J. Randolph and J. Morrison "Modulation Transfer Characteristics of an Acousto Optic Deflector", Applied Optics, pp 1383-1385, Jan. 1971.
6. J.R. Boyde, E.H. Young, and S.K. Yao, "Design Procedure for Wide Bandwidth Acousto-Optic Modulators", Optical Engr. pp 452-454, Sept. 1977
7. E.I. Gordon, "A Review of Acousto-Optical Deflection and Modulation Devices", Proc. IEEE, pp 1391-1401, Oct. 1966
8. I. C. Chang, "Tunable Acousto-Optic Filters; an Overview," SPIE Vol. 90 Acousto-Optics, p.12 (1976).

FIBER OPTICAL APPLICATION REFERENCE:

9. N. S. Bergano, C. R. Davidson, *Journal Lightwave Technology*, 13(5), p879, 1995.
10. K. M. Feng, J. X. Cai, X. P. Chen, A. E. Willner, D. A. Smith, *Proceedings of Conference on Optic Fiber Communication*, p334, Technical Digest Series.
11. Y. Kodama, E. Kolltveit, B. Biotteau, I. Riant, F. Pitel, O. Audouin, P. Brindel, E. Brun, P. Sansonetti, J. P. Hamaide, *IEEE Photonics Technology Letters*, 7(12),p1498,1995.
12. T. Okoshi, K. Kikuchi, A. Nakayama, *Electron. Letters*, 16(16), p630, 1980.
13. H. Tsuchida, *Opt. Letters*, 15(11), p640, 1980.
14. K. Liyama, K. Hayashi, Y. Ida, H. Ikeda, Y. Sakai, *J. Lightwave Technology*, 9(5), p635,1991.
15. J. W. Dawson, N. Park, K. Vahala, *IEEE Photonics Technology Letters*, 4(9), p1063, 1992
16. Hector E. Escobar, "Acousto-optical tunable filters enables dynamic add/drop multiplexing", *Lightwave v 15(10)*, p97, 1998.
17. Dan Sadot, Efraim Boimovich, "Tunable optical filters for dense WDM networks", *IEEE Communications Magazine v 36(12)*, p50-55, 1998.
18. I. C. Chang, "Polarization-independent acousto-optic tunable filter for WDM applications", *Proceedings of the 1997 Conference on Lasers and Electro-Optics, CLEO*, v11 p207, 1997.
19. M. Pitter, E. Jakeman, M. Harris, "Heterodyne detection of enhanced backscatter", *Optics Letters*, v 22(6), p393-395, 1997.
20. B. Devaraj, M. Kobayashi, M. usa, M. Takeda, H. Inaba, H. ishihata, H. HORIUCHI, " First demonstration of laser computed tomography of human tooth by coherent detection imaging", *Electronics Letters*, v 31(11), p 874-876, 1995.

GLOSSARY OF VARIABLES

M_2	- Acoustic Figure of Merit
Pac	- Acoustic Power in Watts
tr	- Modulated Laser Beam Rise Time
DIA	- Laser Beam Diameter
Va	- Acoustic velocity in meters / second
fa	- Acoustic Frequency in MHz
η	- Diffraction Efficiency of Modulator
L	- Interaction Length
H	- Transducer Height
θ_b	- Bragg Angle in radians
θ	- $2\theta_b$ = Deflection Angle in radians
MTF	- Modulation Transfer Function
fm	- Modulation Frequency
fo	- Characteristic Frequency @ cutoff
Imax	- Maximum Intensity
Imin	- Minimum Intensity
CR	- Contrast Ratio
"V"Coat	- Narrow Band AR Coating
AOBD	- Acousto Optic Beam Deflector
D	- Deflector Aperture in meters
$\Delta\Theta$	- Natural Divergence of collimated laser beam with aperture width D
λ	- Optical wave length in free space in meters
N	- Total number of resolvable spots at 40% intensity cross over point
$\Delta\theta$	- Total scan angle in radians
ΔFa	- Total acoustic bandwidth in MHz
ΔT	- Aperture time in seconds
T	- The total linear FM scan time
P	- Truncation factor of the laser beam
W	- Focused beam diameter at $1/e$ intensity
a	- a parameter for uniformity of illumination
FL _a	- Acoustical induced lens focal length
$\frac{dFa}{dt}$	- FM rate
F	- Focal length of a lens
z	- Coordinate in the lens focal plane
Λ	- Acoustical wavelength
E	- Optical field amplitude

TABLE 2

MATERIAL	OPTICAL RANGE	OPTICAL POLARIZATION	MAXIMUM CW LASER POWER	REFRACTIVE INDEX	ACOUSTIC MODE	VELOCITY	FIG. OF MERIT	NEOS SERIES
	Microns		kwatt/cm2			m/sec	X10⁻¹⁵s³/Kg	
AMTIR	1.06-5	Random	5	2.6	L	2.6x10 ³	140	26000
Flint Glass SF6	.45-2	Random	0.12	1.8	L	3.51x10 ³	8	24000
Flint Glass SF10	.45-2	Random	0.12	1.7	L	4.0x10 ³	5	34000
Fused Silica	.2-4.5	Linear	>500	1.46	L	5.96x10 ³	1.5	35000
Fused Silica	.2-4.5	Random	>500	1.46	S	3.76x10 ³	.46	35000
Crystal Quartz	.2-4.5	Random or Linear	750	1.55	I	5.75x10 ³	1.5 / 2.2	33000
Gallium Phosphide	.63-10	Linear	30	3.3	L	6.65x10 ³	29	47000
Gallium Phosphide	.63-10	Random	30	3.3	S	4.13x10 ³	17	47000
Germanium	2.0-10	Linear	0.5	4	L	5.5x10 ³	180	37000
Lithium Niobate	.6-4.5	Linear	0.05	2.2	L	6.6x10 ³	7	45000
Lithium Niobate	.6-4.5	Linear	0.05	2.2	S	3.6x10 ³	15	45000
Tellurium Oxide	.4-5	Random	1 < 633nm 100 > 633nm	2.25	L	4.26x10 ³	34	23000 15000
Tellurium Oxide	.4-5	Circular	1 < 633nm 100 > 633nm	2.25	S	0.62x10 ³	750	45000

FIGURE 10

Deflection characteristics of a Shear Wave TeO₂ AO device

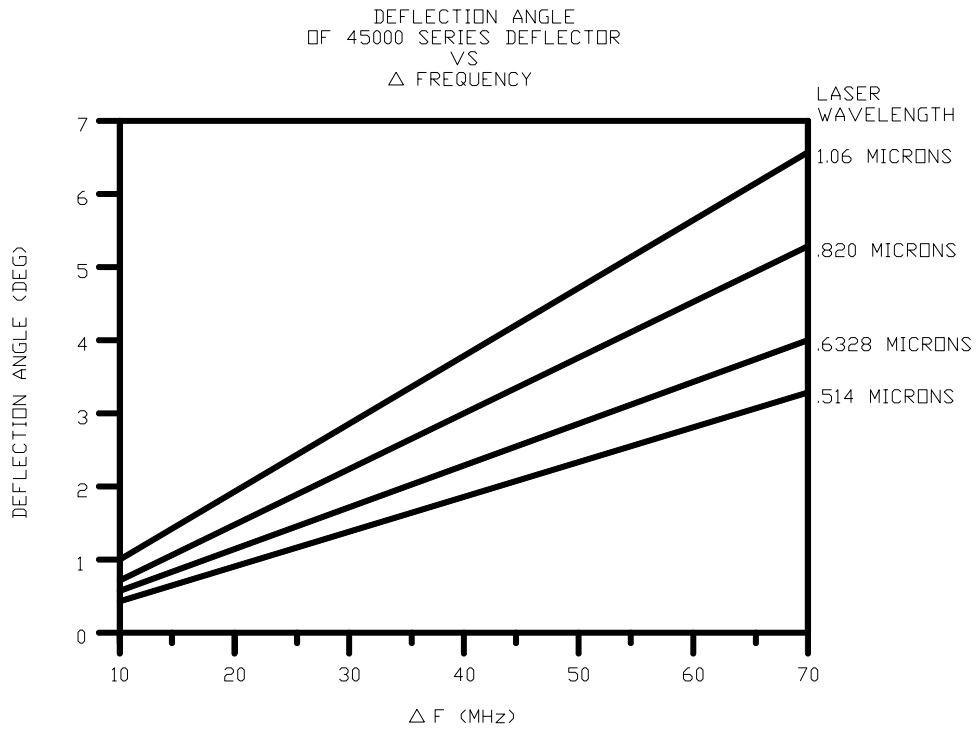

Deflection characteristics of several longitudinal AO devices

